

CFA 4-LEVEL : 1684CFA4L

MODEL 1684 WATER TANK LEVEL INDICATING SYSTEM

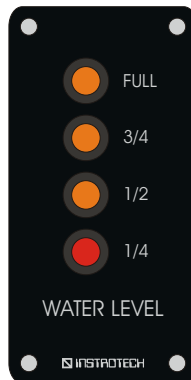

Cab (Master)
100 mcd LED's
50° viewing angle

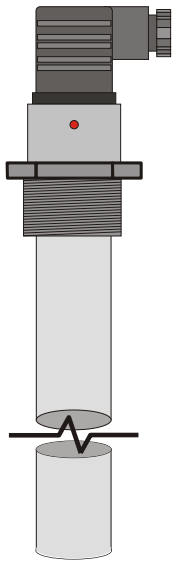
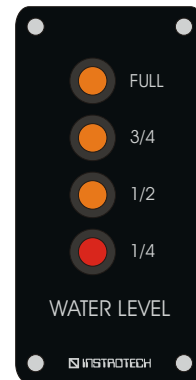

Pump (Slave)
4000 mcd LED's
30° viewing angle

Panel-mount level indicators with 3 amber LED's, 1 red LED and aluminium faceplate

WATER tank sensor with 25mm/1" BSP process connection, LED and DIN plug connector

WIRING DIAGRAM :

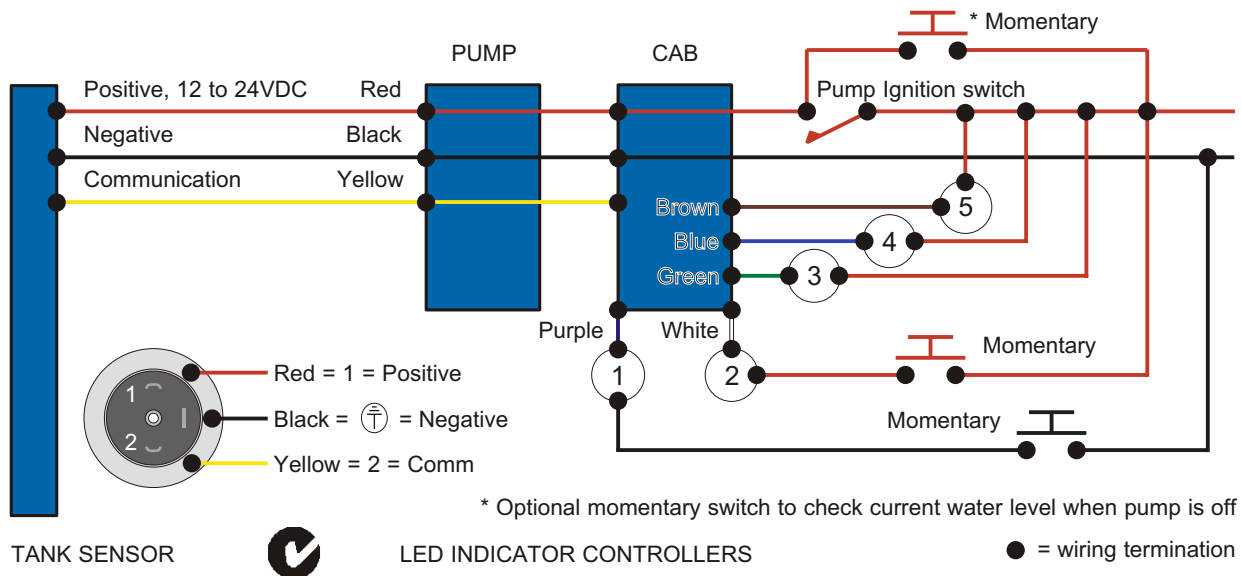

INPUTS:

- 1 Mute Audible 10-minute "Crew Protection" Sirens via momentary switch to *negative*.
- 2 Test Water Level and Alarms via momentary switch to *positive supply when Pump is On or Off*.

OUTPUTS: **Negative switching**

- 3 At 1/4 - Switch On "Low Water" Amber Strobe and Amber Light and Switch Off at 3/4.
- 4 Below 1/4 - Switch On Visual "Crew Protection" Red Lights and Switch Off at 1/4.
- 5 Below 1/4 - Switch On Audible "Crew Protection" Sirens for 10 minutes and Switch Off at 1/4.

CFA 4-LEVEL : 1684CFA4L

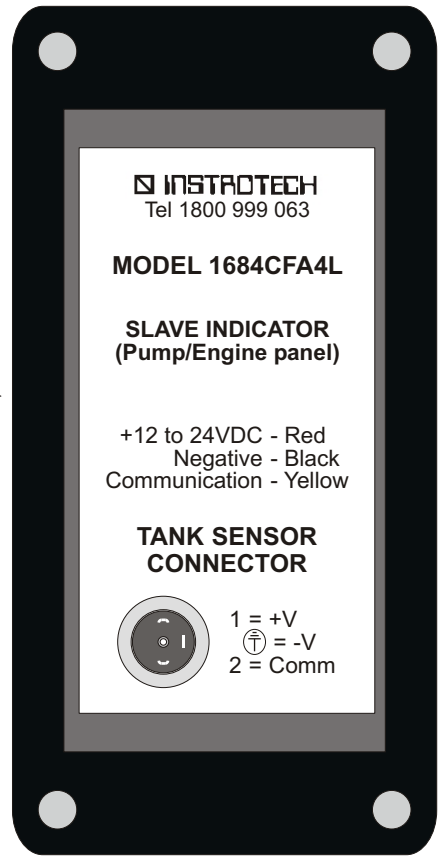
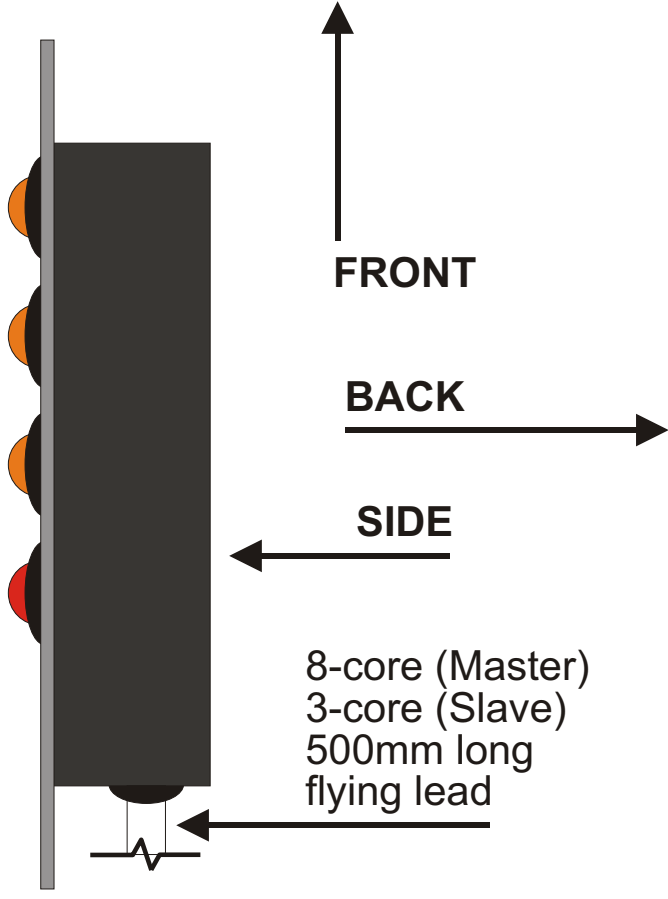
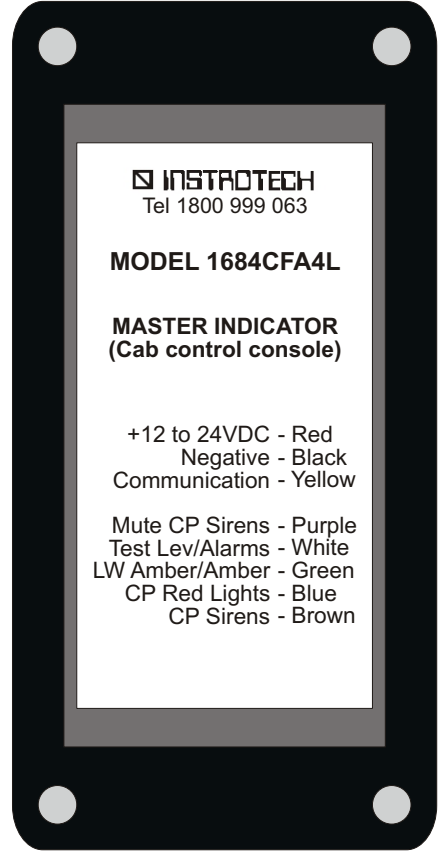
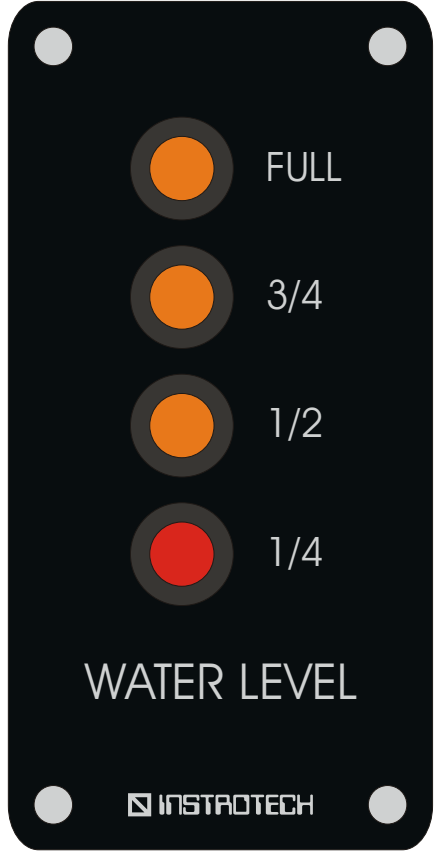

CFA 4-LEVEL : 1684CFA4L

Full scale

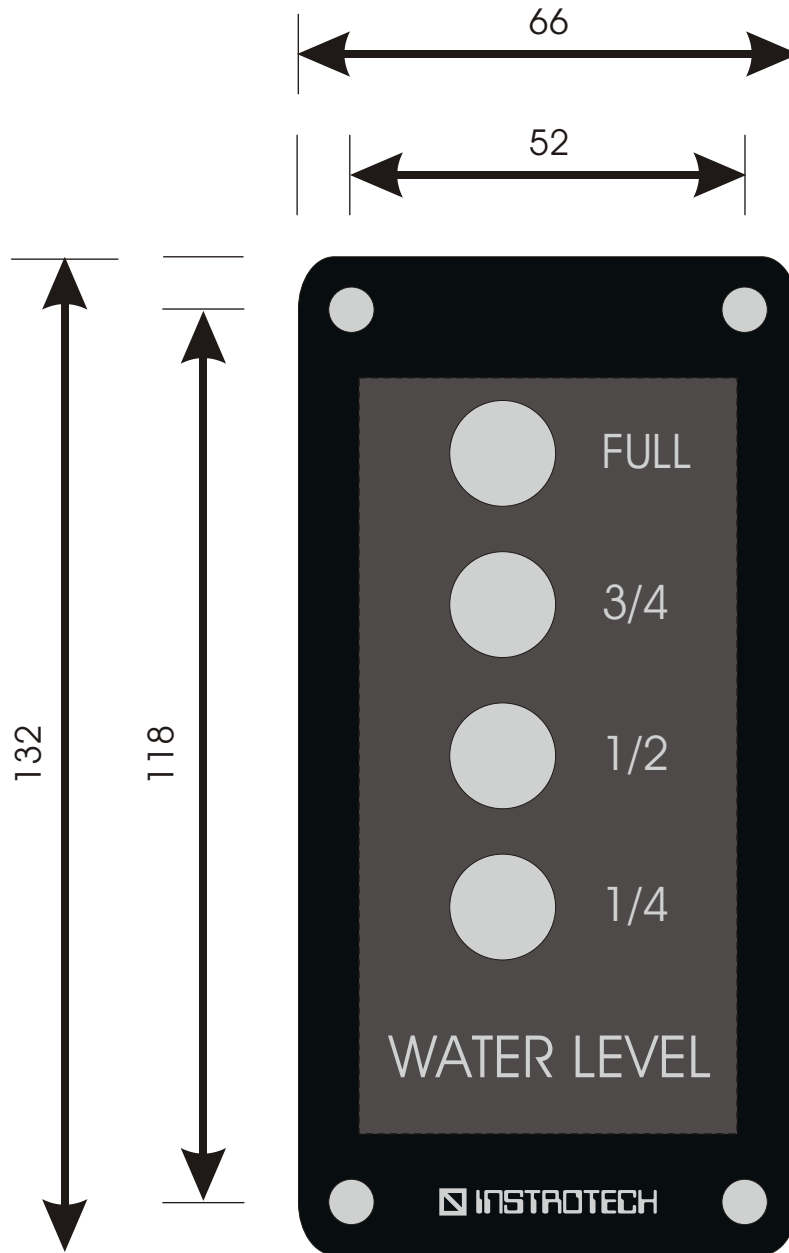

Faceplate - 66 x 132mm high

Enclosure - 50 x 100 x 25mm deep

Panel cut-out - 51 x 103mm high

Mounting holes - 4 x 6mm diameter